



Westinghouse

USER'S MANUAL
MANUEL DE L'UTILISATEUR
MANUAL DEL USUARIO

SK-26H640G

TABLE OF CONTENTS

IMPORTANT INFORMATION 2
 Warnings 2
 NOTICES 3
 FCC COMPLIANCE STATEMENT 4
 IMPORTANT SAFETY INSTRUCTIONS 5
 Circuit Overload 6
 Power Cord Protection 6
 Ventilation 6
 Safety: Lamp Disposal 6
 WARNINGS AND PRECAUTIONS 7
 ANTENNA INSTALLATION SAFETY 8
 Lighting 8
 Power lines 8
 CLEANING THE LCD TV 9
 Dolby-Digital Notice 9
PACKAGE CONTENTS 11
CONTROL PANEL 12
TERMINALS 13
REMOTE CONTROL 14
REMOTE CONTROL OPERATION 15
 INSTALLING THE REMOTE CONTROL BATTERIES .. 15
 REMOTE CONTROL TRANSMISSION RANGE 15
LCD TV BASE 16
 INSTALLING THE LCD TV BASE 16
 REMOVING THE LCD TV BASE 17
ANTENNA CONNECTION 18
 OUTDOOR ANTENNA CONNECTION 18
 CABLE TV (CTV/DTV) CONNECTION 18
EXTERNAL DEVICE CONNECTIONS 19
POWER CONNECTION 21
 CONNECTING AC POWER 21
 INITIAL SETUP 21

English

TABLE OF CONTENTS

BASIC OPERATIONS	22
TURNING THE POWER ON AND OFF	22
ADJUSTING THE VOLUME	22
CHANGING CHANNELS	23
SELECTING THE INPUT SOURCE	23
ADJUSTING THE DISPLAY FORMAT	24
ADJUSTING THE LCD BACKLIGHT	24
SETUP MENUS	25
SETUP MENU OPERATION	25
PICTURE	26
AUDIO	30
VIEW MODE	33
VIEW MODE (VGA)	33
CHANNELS	35
SETTINGS	40
WALL MOUNT OPTION	51
WALL MOUNT INSTALLATION REMINDERS	51
TROUBLESHOOTING	52
SPECIFICATIONS	55

DIGITAL TELEVISION TRANSITION NOTICE

English

DIGITAL TELEVISION TRANSITION NOTICE

This device contains a digital television tuner, so it should receive digital over the air TV programming, with a suitable antenna, after the end of full-power analog TV broadcasting in the United States on June 12, 2009. The nationwide switch to digital television broadcasting will be complete on June 12, 2009, but your local television stations may switch sooner. After the switch, analog-only television sets that receive TV programming through an antenna will need a converter box to continue to receive over-the-air TV. Watch your local stations to find out when they will turn off their analog signal and switch to digital-only broadcasting.

For more information, call the FCC at 1-888-CALL-FCC (1-888-225-5322) or see www.DTV.gov. For information on the TV Converter program, and on government coupons that may be used toward the purchase of one, see www.dtv2009.gov, or call the NTIA at 1-888-DTV-2009.

AVISO RELATIVO A LA TRANSICIÓN A TELEVISIÓN DIGITAL

Este equipo incorpora un sintonizador de televisión digital, lo que le permitirá recibir una programación digital televisada por aire, con una antena adecuada, cuando se terminará la transmisión de alta potencia de la televisión analógica en los Estados Unidos el 12 de Junio de 2009. Ciertos receptores de televisión antiguos, si dependen de una antena de TV, necesitarán un conversor de TV para recibir por el aire una programación digital, pero seguirán funcionando como antes para otros usos (por ejemplo para ver emisoras de TV de baja potencia que todavía transmiten en analógico, para ver películas pregrabadas, o para utilizar sus videojuegos).

Para obtener más información, llame FCC 1-888-CALL-FCC (1-888-225-5322) o refiérase a www.DTV.gov. Para toda información sobre el programa de conversores de TV, y acerca de los cupones del gobierno que se pueden usar para comprarlos, refiérase a www.dtv2009.gov, o llame al NTIA al 1-888-DTV-2009.

IMPORTANT INFORMATION

English

IMPORTANT INFORMATION

To reduce the risk of fire or electric shock:

- Do not expose this product to rain or moisture.
- Do not remove the rear cover. There are no user-serviceable parts inside. Refer all servicing requirements to qualified service personnel.
- The plug should be connected to a mains socket outlet with a protective earthing connection.

Warnings

To reduce the risk of fire or electric shock:

- Do not expose this product to rain or moisture.
- Do not remove the rear cover. There are no user-serviceable parts inside. Refer all servicing requirements to qualified service personnel.
- The plug should be connected to a mains socket outlet with a protective earthing connection.



The lightning flash with arrowhead inside an equilateral triangle symbol is intended to alert the user to the presence of uninsulated dangerous voltage within the product's enclosure that may be of sufficient magnitude to constitute a risk of electric shock.



The exclamation inside an equilateral triangle symbol is intended to alert the user to related operating and maintenance instructions in the user documentation accompanying the product.

WARNING!

This device must be operated with the original power supply.

IMPORTANT INFORMATION

CAUTION:

The power supply outlet should be located near the LCD TV and should be easily accessible.

Always use the appropriate AC cord that is certified for your specific country. Some examples are listed below:

- USA – UL
- Canada – CSA
- Japan – Electric Appliance Control Act

NOTICES

Important Notices Concerning Power Cord Selection

The specific power cord for this LCD TV is enclosed and has been selected according to the country of destination. Use the enclosed power cord to prevent electric shock. Observe the following guidelines if it is necessary to replace the original cord set, or if there is no cord set enclosed. The female receptacle of the cord set must meet IEC-60320 requirements and should look like Figure A1 below:

Figure A1

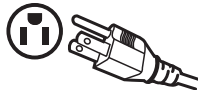

Figure A2

For the United States and Canada

In the United States and Canada the male plug is a NEMA5-15 style (Figure A2), UL-listed, and CSA-labeled. For LCD TVs that are to be placed on a desk or table, type SVT or SJT cord sets may be used. For LCD TVs that are to be placed directly on the floor, only SJT type cord sets may be used. The cord set must be selected according to the current rating for the LCD TV. Consult the table below for the selection criteria of power cords used in the United States and Canada.

Cord Type	Size of Conductor in Cord	Maximum Unit Current Rating
SJT	18 AWG	10 Amps
	16 AWG	12 Amps
	14 AWG	12 Amps
SVT	18 AWG	10 Amps
	17 AWG	12 Amps

IMPORTANT INFORMATION

English

FCC COMPLIANCE STATEMENT

This equipment has been tested and complies with the limits for a Class B digital device, pursuant to part 15 of the FCC Rules. These limits are designed to provide reasonable protection against harmful interference in a residential installation. This equipment generates, uses, and can radiate radio frequency energy, and may cause harmful interference to radio communications if not installed and used in accordance with the instructions. However, there is no guarantee that interference will not occur in a particular installation. If this equipment does cause harmful interference to radio or television reception, which can be determined by turning the equipment off and on, the user is encouraged to try to correct the interference by one or more of the following measures:

- Reorient or relocate the receiving antenna.
- Increase the distance between the LCD TV and the receiver.
- Connect the LCD TV to an outlet on a circuit separate from to which the receiver is connected.
- if the interference persists even after performing the above measures, consult the Westinghouse Service Center or an experienced radio/TV technician for assistance.

FCC Warning

To assure continued FCC compliance, use a grounded power supply cord and the provided shielded video interface cable with bonded ferrite cores. If a BNC cable is used, use only a shielded BNC (5) cable. Also, any unauthorized changes or modifications not expressly approved by the manufacturer will void the user's authority to operate this device.

IMPORTANT INFORMATION

IMPORTANT SAFETY INSTRUCTIONS

Make sure to note and follow all warnings and instructions marked on the LCD TV. Observe the following safety instructions.

- Read these instructions.
- Keep these instructions.
- Heed all warnings.
- Follow all instructions.
- Do not use this apparatus near water.
- Clean only with dry cloth.
- Do not block any ventilation openings. Install in accordance with the manufacturer's instructions.
- Do not install near any heat sources such as radiators, heat registers, stoves, or other apparatus (including amplifiers) that produce heat.
- Do not defeat the safety purpose of the polarized or grounding-type plug. A polarized plug has two blades with one wider than the other. A grounding type plug has two blades and a third grounding prong. The wide blade or the third prong are provided for your safety. If the provided plug does not fit into your outlet, consult an electrician for replacement of the obsolete outlet.
- Protect the power cord from being walked on or pinched particularly at plugs, convenience receptacles, and the point where they exit from the apparatus.
- Only use attachments/accessories specified by the manufacturer.
- Use only with the cart, stand, tripod, bracket, or table specified by the manufacturer, or sold with the apparatus. When a cart is used, use caution when moving the cart/apparatus combination to avoid injury from tip-over.



- Unplug this apparatus during lightning storms or when unused for long periods of time.
- Refer all servicing to qualified service personnel. Servicing is required when the apparatus has been damaged in any way, such as power-supply cord or plug is damaged, liquid has been spilled or objects have fallen into the apparatus, the apparatus has been exposed to rain or moisture, does not operate normally, or has been dropped.

IMPORTANT INFORMATION

Circuit Overload

Do not overload wall outlets, extension cords, or power strips. This can result in a fire or electronic shock.

Power Cord Protection

Power supply cords should be routed so that they are not likely to be walked on or pinched by items placed upon or against them. Periodically inspect the cords for damage. Install the LCD TV near a wall socket outlet where the power cord can be readily accessed.

Ventilation

The slots and openings on the cabinet are provided for necessary ventilation. To ensure reliable operation of the LCD TV and to protect it from overheating, these slots and openings must never be blocked or covered.



Never cover the slots and openings with a cloth or other materials.



Do not block the openings by placing the LCD TV on a bed, sofa, rug or other similar surface.



Do not place the LCD TV in a built-in installation such as a bookcase or a rack unless proper ventilation is provided or the manufacturer's instructions have been adhered to.

Safety: Lamp Disposal

Lamp(s) inside this product contain mercury and must be recycled or disposed of according to local, state or federal laws. For more information, contact the electronic industries alliance at www.eiae.org.

WARNINGS AND PRECAUTIONS

- Do not orient the LCD TV towards direct sunlight to reduce glare.
- If the LCD TV will not be used for a long period of time, unplug the unit and remove the batteries from the remote control.
- Avoid touching the display screen by hand or any object.
- Never remove the rear cover. The LCD TV interior contains high-voltage parts. You may be seriously injured if you touch them.
- Always handle the LCD TV with caution when moving it.
- Do not install the LCD TV in airtight compartments, or in areas where it can be exposed to water or high temperature.
- Ensure that the area around the LCD TV is clean and free of moisture.
- Do not place anything on the LCD TV that can hinder heat dissipation.
- Do not place naked flame sources, such as lighted candles, on or near the LCD TV.
- Do not place anything on the LCD TV that can cause liquid to splash on it (e.g. flower vase).
- Do not place heavy objects on the LCD TV, audio/video cables, or power cord.
- If the LCD TV emits smoke, abnormal noise, or a strange odor, immediately turn it off and contact the Westinghouse Service Center by:
 - Logging on to www.wde.com.
 - Contacting the Westinghouse Customer Service at (866) 287-5555.
 - E-mailing us at service@wde.com.

IMPORTANT INFORMATION

English

ANTENNA INSTALLATION SAFETY

Outdoor Antenna Grounding

If an outside antenna or cable system is connected to the LCD TV, be sure the antenna or cable system is grounded to prevent voltage surges and built-up static charges. Article 810 of the National Electrical Code, ANS/NFPA 70, provides information on proper grounding of the mast and supporting structure, grounding of the lead-in wire to an antenna discharge unit, connection to grounding electrodes, and requirements for the grounding electrode.

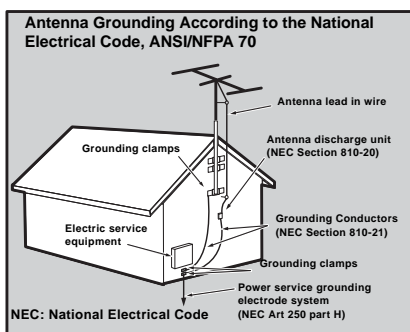

Lighting

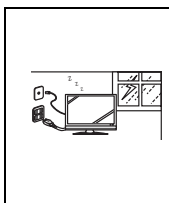

For added protection for the LCD TV during a lightning storm, or when it is left unattended and unused for long periods of time, unplug it from the wall outlet and disconnect the antenna or cable system. **DO NOT** disconnect the antenna or the power cord during a heavy storm—lightning may strike while you are holding the cable cord, causing serious injury. Turn off the LCD TV and wait for the weather to improve.

Power lines

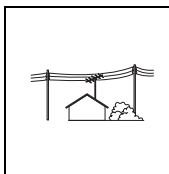

An outside antenna system should not be located in the vicinity of overhead power lines or other electric light or power circuits, or where it can fall into such power lines or circuits. When installing an outside antenna system, extreme care should be taken to keep from touching such power lines or circuits as contact with them might be fatal.

IMPORTANT INFORMATION

CLEANING THE LCD TV



- Make sure the LCD TV is turned off and the power cord is disconnected from the power outlet.
- Never spray or pour any liquid directly onto the screen or the case.

To clean the screen:

- 1 Wipe the screen with a clean, soft, lint-free cloth. This removes dust and other particles.
- 2 If it is still not clean, apply a small amount of non-ammonia, non-alcohol based glass cleaner onto a clean, soft, lint-free cloth, and wipe the screen.

To clean the case:

- 1 Wipe the case with a soft, dry cloth.
- 2 If it is still not clean, apply a small amount of non-ammonia, non-alcohol based, mild non-abrasive detergent onto a clean, soft, lint-free cloth, then wipe the surface.

Dolby-Digital Notice



Manufactured under license from Dolby Laboratories. Dolby and the double-D symbol are registered trademarks of Dolby Laboratories.







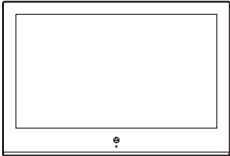

IMPORTANT INFORMATION

English

PACKAGE CONTENTS

English

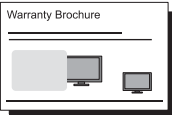
PACKAGE CONTENTS

<p>26" LCD TV Unit</p>	<p>Remote Control (with 2x AAA batteries)</p>
	
<p>LCD TV Base</p>	<p>Quick Connect Guide</p>
	
<p>Power Cord</p>	<p>Warranty Card</p>
	
<p>User Manual</p>	<p>Warranty Brochure</p>
	
<p>Product Brochure</p>	<p>M4 x L10 mm Screw for Base</p>
	

CONTROL PANEL

English

CONTROL PANEL

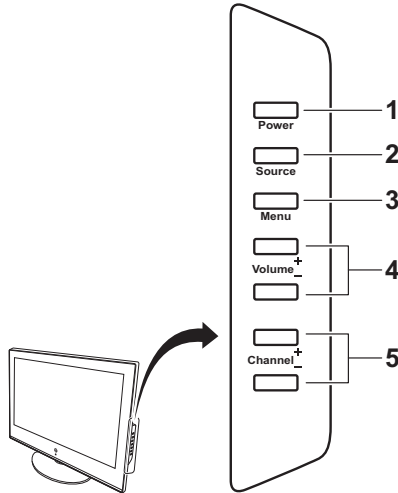

Item	Description
1. Power	Toggles the power on and off.
2. Source	Select the video input source; in a menu screen, execute a command.
3. Menu	Display the LCD TV setup screen.
4. Volume +/-	During playback, adjust the volume; in a menu screen, select an item.
5. Channel +/-	During TV viewing, adjust the channel; in a menu screen, select an item.

TERMINALS

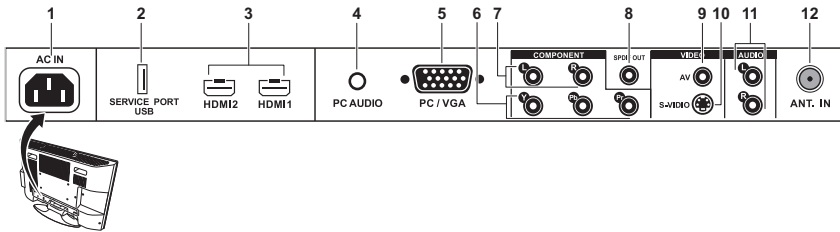

English

Item	Function
1. AC in	Connect the power cord from this outlet to a power source.
2. Service port USB	For service only.
3. HDMI 1 / 2	Connect to an external video device such as a DVD player, game system, cable, or satellite box.
4. PC Audio in	Connect to the audio out port of a computer.
5. PC VGA	Using a 15-pin VGA cable, connect to a computer or other device with a VGA output.
6. YPbPr input	Connect an external video device with component output to these jacks.
7. YPbPr audio input	Connect an external audio source.
8. SPDIF (Coaxial) audio out	Connect this output to an external digital audio receiver.
9. Composite video input	Connect to an external video device with an analog signal such as a VCR.
10. S-Video input	Connect an external S-video device such as a DVD player using an S-video cable.
11. AV & S-VIDEO audio output	Connect this output to an external audio receiver.
12. TV turner	Connect the LCD TV to an antenna or cable service.

REMOTE CONTROL

REMOTE CONTROL

English

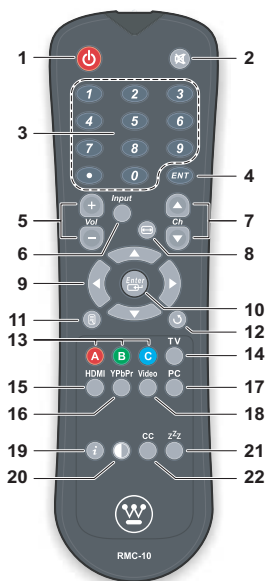

Item	Description
1. Power	Toggle the TV power on and off.
2. Mute	Mute the sound. Press it again to toggle the sound back on.
3. Channel keys	Key in the channel number.
4. Enter ENT	Execute a channel entry.
5. Vol +/-	Adjust the system volume.
6. Input	Select the video input source.
7. Ch ▲ / ▼	Change the current TV channel.
8. Aspect ratio	Select the video display format.
9. Arrow keys ▲ / ▼ / ◀ / ▶	Navigate through the on-screen menu.
10. Enter	Execute a command.
11. Menu	Display the LCD TV setup screen.
12. Return	Switch to a previously bookmarked channel.
13. Favorite	Switch to the favorite channels.
14. TV	Enable TV or HDTV as the input source.
15. HDMI	Enable HDMI 1 or HDMI 2 as the input source.
16. YPbPr	Enable YPbPr as the input source.
17. PC	Enable VGA as the input source.
18. Video	Enable video as the input source.
19. Info	Display the input source or channel information, as well as the system date and time.
20. Backlight	Adjust the LCD screen backlight.
21. Sleep zZz	Set the sleep timer for the LCD TV to turn off automatically.
22. CC	Toggle the closed caption display on and off.

REMOTE CONTROL OPERATION

INSTALLING THE REMOTE CONTROL BATTERIES

CAUTIONS:

- Only use AAA batteries.
- Do not mix new and old batteries. This may result in cracking or leakage, which may pose a fire risk or lead to personal injury.
- Insert batteries according to the (+) and (-) markings. Inserting the batteries incorrectly may result in cracking or leakage, which may pose a risk of fire or lead to physical injury.
- Dispose of used batteries in accordance with local laws and regulations.
- Keep batteries away from children and pets.
- When the remote control will not to be used for an extended period, remove the batteries.

- 1 Remove the battery cover.
- 2 Insert the batteries. Make sure the (+) and (-) marks on the batteries match those inside the compartment.
- 3 Re-attach the battery cover.



REMOTE CONTROL TRANSMISSION RANGE

Transmission range depends upon the reception angle. The range of coverage is 20° horizontal/vertical at a distance of 10 feet from the LCD TV.



LCD TV BASE

CAUTION:

The LCD TV unit may be too heavy for one person to lift. If this is the case, make sure to ask for assistance in handling the LCD TV to prevent physical injury and/or damage to the unit.

INSTALLING THE LCD TV BASE

- 1 Open the LCD TV carton box.
- 2 Remove the LCD TV base.
- 3 Remove the plastic bag.
- 4 Remove the two top carton stabilizers from the LCD TV.
- 5 Remove the protective plastic covering the LCD TV.
- 6 Grasp the two sides of the LCD TV and then pull it out of the carton box.
- 7 Remove the two bottom carton stabilizers from the LCD TV.
- 8 Lay the LCD TV on a clear, flat, and stable surface.
- 9 Align the base to the bottom side of the LCD TV and use one M4 x L10 mm screw to secure it.

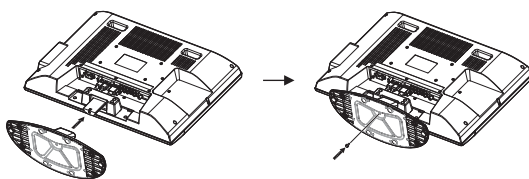

- 10 Carefully orient the LCD TV in an upright position.

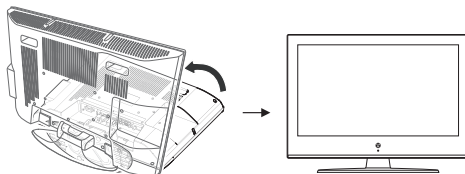

REMOVING THE LCD TV BASE

If you intend to repack the LCD TV unit (for shipping or storage) or you want to change the installation to a wall mount option, you must first remove the LCD TV base.

- 1 Turn off the LCD TV and all connected devices.
- 2 Disconnect the power cord from the LCD TV.
- 3 Disconnect all signal cables from the I/O port terminals.
- 4 Lay the LCD TV on a clear, flat, and stable surface.

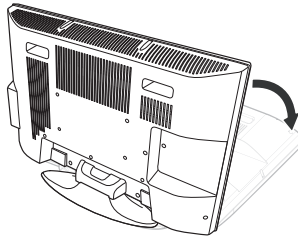

- 5 Remove the screw securing the base to the LCD TV.
- 6 Detach the base from LCD TV.

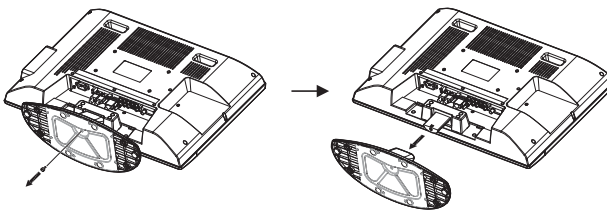

- 7 Pack the screws you removed in step 5 together with the LCD TV base for future reassembly.

ANTENNA CONNECTION

ANTENNA CONNECTION

OUTDOOR ANTENNA CONNECTION

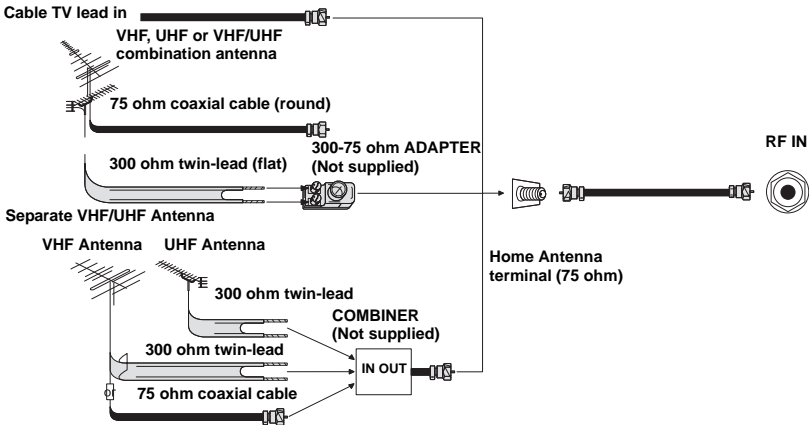

English

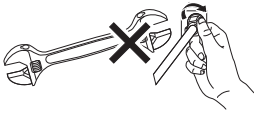

NOTE:

The F-type connector should be finger-tightened only. When connecting the RF cable to the LCD TV, do not tighten F-type connector with any tool. If tools are used, it may cause damage to the LCD TV (e.g. breaking of internal circuit).

CABLE TV (CTV/DTV) CONNECTION

The unit has a TV tuner (75 ohm coaxial cable connector) located on the rear I/O panel for easy cable hookup. When connecting the 75 ohm coaxial cable to the unit, screw the 75 ohm cable to the TV tuner. Some cable TV companies offer premium pay channels. Since the signals of these channels are scrambled, a cable TV converter/descrambler is usually provided to the subscriber by the cable TV company. This converter/descrambler is necessary for normal viewing of the scrambled channels. (Set your TV to channel 3 or 4. Typically one of these channels is used. If a channel is unknown, consult your cable TV company.) For more specific instructions on installing cable TV, consult your cable TV company. One possible method of utilizing the converter/descrambler provided by your cable TV company is explained below.

EXTERNAL DEVICE CONNECTIONS

- A position on the RF switch (not supplied) – You can view all unscrambled channels by using the TV's channel keys.
- B position on the RF switch (not supplied) – You can view the scrambled channels via the converter/descrambler by using the converter's channel keys.

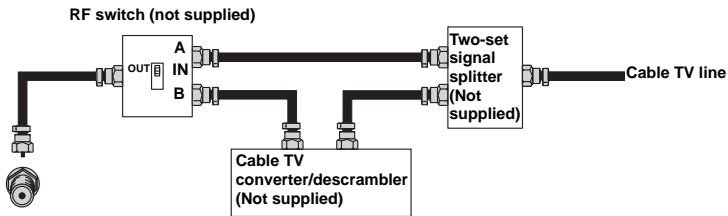

English

EXTERNAL DEVICE CONNECTIONS

IMPORTANT:

- Turn off the LCD TV first before connecting an external device to prevent any possible damage or physical injury.
- For more information about external device connections, see the operation manual of the external device you wish to connect to the LCD TV.
- Make sure that the correct cables are connected to each terminal. Improper cable connections may cause damage to the LCD TV.

You can enjoy picture and sound by connecting various audio-video devices to the terminals located on the rear and side I/O panels of the LCD TV.

- TV cable input – You can use a commercially available audio/video cable.
- Component (YPbPr) input – Picture can be displayed only when a 480i, 480P, 720P or 1080i signal is received.
- HDMI input – Picture can be displayed only when a 640 x 480, 480P, 720P or 1080i signal is received. When you connect to the HDMI terminal with a DVI-HDMI conversion cable, there is a possibility that the picture may not display correctly.
- Audio output – You can output audio signals from the LCD TV set through the analog audio out and SPDIF terminals.

EXTERNAL DEVICE CONNECTIONS

The following diagram shows the external device connections.

English

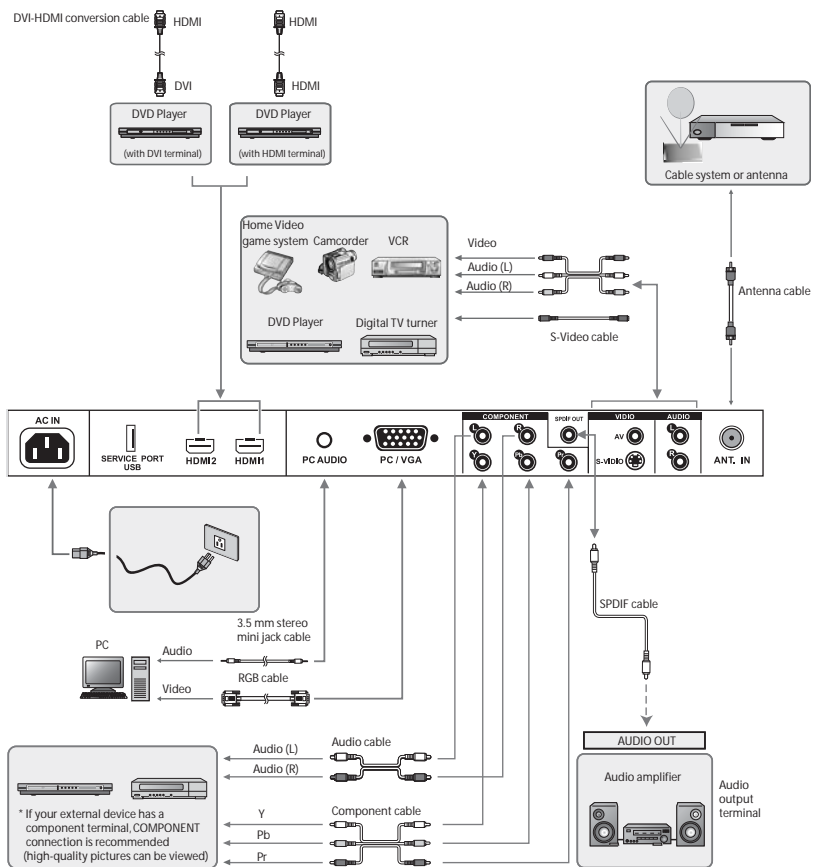

POWER CONNECTION

CONNECTING AC POWER

IMPORTANT:

The LCD TV works on a 120 VAC, 60 Hz power input voltage **ONLY**. Turn off all connected devices before plugging in the power cord.

Connect the power cord to the LCD TV then to a proper AC outlet.

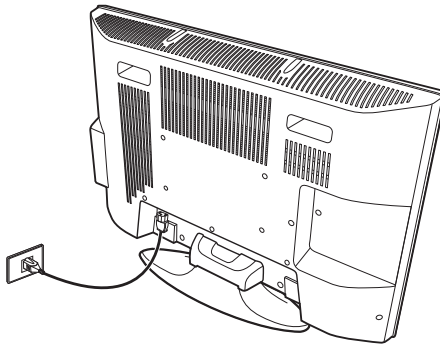

English

INITIAL SETUP

Press  on the control panel or on the remote control to turn on the LCD TV. Select the desired language and select **Yes** to use the SetupWizard. The SetupWizard will guide you on how to set up the LCD TV's operational settings.

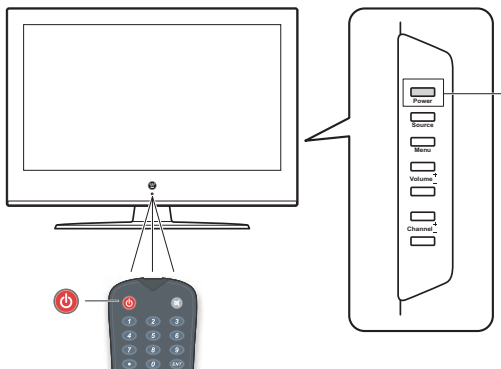

BASIC OPERATIONS

BASIC OPERATIONS

TURNING THE POWER ON AND OFF

Turning on the power

Press  on the control panel or on the remote control to turn on the LCD TV.

Turning off the power

Press  on the control panel or on the remote control to turn off the LCD TV. The LED behavior will depend on the enabled Power settings.

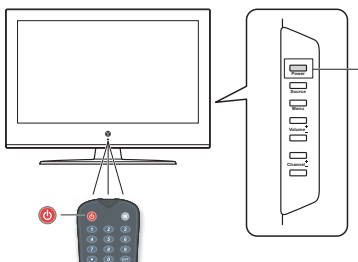

LED Behavior	Description
Turns from amber to blue when power on and turns from blue to amber when power off.	When LED Setting is set to ON.
Remains in blue.	When LED Settings is set to OFF.

NOTES:

- If you are not going to use the TV for a long time, be sure to disconnect the power cord from the wall outlet and remove the batteries from the remote control.
- In standby mode, a small amount of electricity is still consumed even when the power is turned off.

ADJUSTING THE VOLUME



Volume

Press **Vol+** to increase the volume; press **Vol-** to decrease the volume.

Mute

Press  to turn off the sound. Mute appears on the volume bar. Press again to turn on the sound.

CHANGING CHANNELS

Referred to in the following instructions to change channels.

Using the Ch ▲ / ▼ Buttons



Browse channels

To browse through the available channels, press **Ch ▲ / ▼** on the remote control or on the control panel.

Using the Channel Keys



Selecting channel

To change to a certain channel, key in the channel number using the channel keys and press **ENT**.

Selecting digital channel

To select a digital channel, key in the digital channel number using the channel keys and the **•** key then press **ENT**.

Using the Favorite Keys



Selecting favorite channels

To select a favorite channel, press the **Favorite** button (A, B, or C) corresponding to the preferred favorite channel.

Saving a channel as a favorite

- 1 Display the channel you want to add as a favorite.
- 2 Press and hold the Favorite channel key you want to add the current channel to.
- 3 The Channel Saved message appears to confirm the new favorite channel item.

SELECTING THE INPUT SOURCE

There are two ways to select the video input source.

Using the Individual Input Keys



TV, PC, Video, YPbPr, HDMI Keys

Press any of the following remote control keys to change the input source: **TV, PC, Video, YPbPr, or HDMI**.

BASIC OPERATIONS

Using the Input Key



Select source using Input Key

- 1 Press **Input**.
- 2 A list of supported video sources is displayed.
- 3 Press ◀ / ▶ to select the preferred source.
- 4 Press  to switch to the selected input source.

English

ADJUSTING THE DISPLAY FORMAT

The input source can sometimes affect the way images are displayed on-screen. You can adjust the display format to view the image properly.



Format Options

Press  repeatedly to toggle the display format. As you toggle each option on, the actual display will change accordingly. Options include:

- **Standard:** Picture is displayed in its original size.
- **Fill:** Picture is displayed to cover the entire screen.
- **Overscan:** Picture is scaled down to fit the display area.
- **1:1 Mode:** Matches the incoming resolution exactly to the pixels without any scaling.

ADJUSTING THE LCD BACKLIGHT

Different viewing conditions can affect the quality of the display. You can adjust the LCD backlight to suit the current viewing condition.

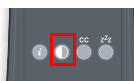

Backlight options

Press  repeatedly to toggle the Backlight options: **Bright Room**, **Medium Room**, and **Dark Room**.

SETUP MENUS

SETUP MENU OPERATION

Use the setup menus to configure the various operational settings of the LCD TV.







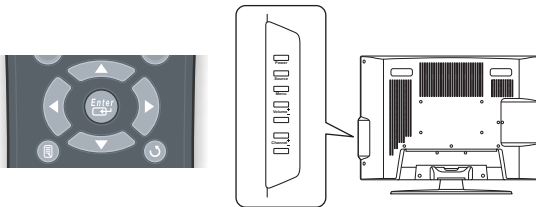

Displaying the setup menu screen

Press  on the remote control or **Menu** on the control panel to display the setup menu screen.

Navigating the setup menu screen

Use the buttons on the remote control or on the control panel to navigate through the menu screens.



Action	Remote Control	Control Panel
Display or close the menu bar.		MENU
<ul style="list-style-type: none"> Select and display a primary menu. Adjust sub-menu options. 	 /  then 	Volume +/- then Source
<ul style="list-style-type: none"> Select and display a sub-menu. Select a menu or a sub-menu option. 	 /  then 	Channel +/- then Source
<ul style="list-style-type: none"> Return to the primary menu tab from a sub-menu screen. Return to the previous screen. 		Menu
Apply the selected menu setting or cycle through available menu options.		Source

SETUP MENUS

English

PICTURE

Use the Picture sub-menus to configure the display quality.



Press  on the remote control or **Menu** on the control panel to display the setup menu screen then select **Picture** to display the Picture sub-menu. The following options are available: Brightness, Contrast, Saturation, Video Presets, Sharpness, Color temperature, Hue, and Reset.

Brightness

Use Brightness to adjust the luminance level.



Adjusting Brightness



- 1 Use the ◀ / ▶ keys to select **Brightness** and press .
- 2 Press the ◀ / ▶ keys on the remote control to adjust the option level.
- 3 Press  to save and exit the screen.

Contrast

Use Contrast to adjust the brightness to darkness ratio.



Adjusting Contrast



- 1 Use the ◀ / ▶ keys to select **Contrast** and press .
- 2 Press the ◀ / ▶ keys on the remote control to adjust the option level.
- 3 Press  to save and exit the screen.

Saturation

Use Saturation to adjust the color intensity.



Adjusting Saturation

- 1 Use the ◀ / ▶ keys to select **Saturation** and press .
- 2 Press the ◀ / ▶ keys on the remote control to adjust the option level.
- 3 Press  to save and exit the screen.

Video Presets

Use this sub-menu to select one of four preset view options optimized for different viewing conditions.





The following options are available:

- **Showroom:** Increased color and sharpness for a vibrant picture display.
- **Movie:** Images are displayed as accurately near to its original recording condition.
- **Game:** Increased brightness and response time level for enjoying video games.
- **Sports:** High contrast display for clear-cut images ideal for viewing sports events.
- **Custom:** Customize your own settings.

SETUP MENUS

Adjusting Video Presets



- 1 Use the ◀ / ▶ keys to select **Video Presets** and press .
- 2 Press the ◀ / ▶ keys on the remote control to select the desired option.
- 3 Press  to save and exit the screen.

Sharpness

Use Sharpness to adjust the sharpness or softness of the display.



Adjusting Sharpness

- 1 Use the ◀ / ▶ keys to select **Sharpness** and press .
- 2 Press the ◀ / ▶ keys on the remote control to adjust the option level.
- 3 Press  to save and exit the screen.

Color Temperature



Color temperature refers to the level of white balance in the display.



There are three available settings:

- **Warm:** Pictures appear more reddish.
- **Neutral:** Pictures appear more white.
- **Cool:** Pictures appear with a bluish tint.

Adjusting Color Temperature



- 1 Use the ◀ / ▶ keys to select **Color temperature** and press .
- 2 Press the ◀ / ▶ keys on the remote control to select the desired option.
- 3 Press  to save and exit the screen.

Hue

Use Hue to adjust the balance of the red, green, and blue colors in the display.



Adjusting Hue

- 1 Use the ◀ / ▶ keys to select **Hue** and press .
- 2 Press the ◀ / ▶ keys on the remote control to adjust the option level.
- 3 Press  to save and exit the screen.

Reset

Select **Yes** on this sub-menu to reset all display-related settings.



NOTE:

The configuration settings for the Picture sub-menus will only be applied to the current input source.

SETUP MENUS

AUDIO

Use the Audio sub-menus to configure the audio quality. These settings apply to the LCD TV speakers only. Any connected audio devices are not affected.



Press  on the remote control or **Menu** on the control panel to display the setup menu screen then select **Audio** to display the Audio sub-menu. The following options are available: Bass, Treble, Balance, TV Speaker, Audio Presets, and Reset.

Bass

Use Bass to calibrate low-pitched sounds.



Adjusting Bass



- 1 Use the ◀ / ▶ keys to select **Bass** and press .
- 2 Press the ◀ / ▶ keys on the remote control to adjust the option level.
- 3 Press  to save and exit the screen.

Treble

Use Treble to calibrate high-pitched sounds.



Adjusting Treble



- 1 Use the ◀ / ▶ keys to select **Treble** and press .
- 2 Press the ◀ / ▶ keys on the remote control to adjust the option level.
- 3 Press  to save and exit the screen.

Balance

Use Balance to adjust the sound balance between the L/R speakers.



Adjusting Balance



- 1 Use the ◀ / ▶ keys to select **Balance** and press .
- 2 Press the ◀ / ▶ keys on the remote control to adjust the option level.
- 3 Press  to save and exit the screen.

TV Speaker

Use this sub-menu to toggle the LCD TV speakers on and off.



Adjusting TV Speaker

- 1 Use the ◀ / ▶ keys to select **TV Speaker** and press .
- 2 Press the ◀ / ▶ keys on the remote control to select **ON** or **OFF**.
- 3 Press  to save and exit the screen.

SETUP MENUS

English

Audio Preset



Use this sub-menu to select one of four preset audio options optimized for different sounding conditions.



The following options are available:

- **Rock:** Sets the equalizer to the Rock mode.
- **Pop:** Sets the equalizer to the Pop mode.
- **Classical:** Sets the equalizer to the Classical mode.
- **Flat:** Sets the equalizer to the Flat mode.
- **Custom:** Allows you to customize the equalizer settings.

Adjusting Audio Preset

- 1 Use the ◀ / ▶ keys to select **Audio Preset** and press .
- 2 Press the ◀ / ▶ keys on the remote control to select the desired option.
- 3 Press  to save and exit the screen.

Reset

Select **Yes** on this sub-menu to reset all audio-related settings.

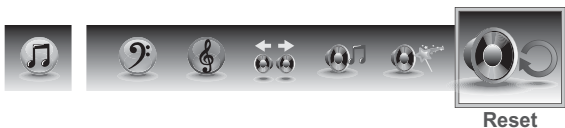

VIEW MODE

Use the View Mode sub-menu to select the display's aspect ratio.



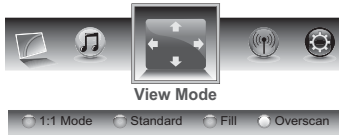

Press  on the remote control or **Menu** on the control panel to display the setup menu screen then select **View Mode** to display the View Mode sub-menu.



The following options are available:

- **1:1 Mode:** Matches the incoming resolution exactly to the pixels without any scaling.
- **Standard:** Picture is displayed in its original size.
- **Fill:** Picture is displayed to cover the entire screen.
- **Overscan:** Picture is scaled down to fit the display area.

Adjusting View Mode

- 1 Press the  /  keys on the remote control to select the desired option.
- 2 Press  or  to save and exit the screen.

VIEW MODE (VGA)

Select **PC** as your input source and use the View Mode sub-menu to adjust the display in VGA mode.

Press  on the remote control or **Menu** on the control panel to display the setup menu screen then select **View Mode** to display the View Mode sub-menu.

The following options are available:

Aspect Ratio

Use this sub-menu to select the display's aspect ratio in the following options:

- **1:1 Mode:** Matches the incoming resolution exactly to the pixels without any scaling.
- **Standard:** Picture is displayed in its original size.
- **Fill:** Picture is displayed to cover the entire screen.

SETUP MENUS

- **Overscan:** Picture is scaled down to fit the display area.



H. Position

Use this sub-menu to adjust the display's horizontal position.



V. Position

Use this sub-menu to adjust the display's vertical position.



Fine Tune

Use this sub-menu to fine tune the display.

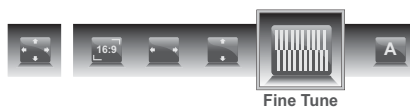

Auto Sync

Use this sub-menu to synchronize the display automatically.



CHANNELS

Use the Channels sub-menus to manage the channel list, language sound, and to scan for available TV channels in your area.







Press  on the remote control or **Menu** on the control panel to display the setup menu screen then select **Channels** to display the Channels sub-menu. The following options are available: Favorite, Skip List, Channel Edit, MTS, Audio Language, Auto Search, and Manual Add.

Favorite

Use Favorite to add your favorite channels.



Adding Favorite Channels

- 1 Use the  /  keys to select **Favorite** and press . The Favorite List screen appears.
- 2 Use the  /  keys to select the desired channel.
- 3 Press  repeatedly to check (add to the Favorite list) or uncheck (clear to the Favorite list) the channels.
- 4 Repeat steps 2 and 3 to add more channels.
- 5 Press  to save and exit the screen.

Skip List

Use Skip List to select the channels you want to skip.

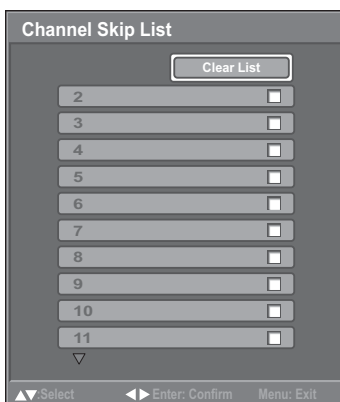

English

Adding Channels to Skip List

- 1 Use the ◀ / ▶ keys to select **Skip List** and press . The Channel Skip List screen appears.
- 2 Use the ▲ / ▼ keys to select the desired channel.
- 3 Press repeatedly to check (add to the Skip list) or uncheck (clear to the Skip list) the channels.
- 4 Repeat steps 2 and 3 to add more channels.
- 5 Press to save and exit the screen.

Channel Edit

Use Channel Edit to assign a name to a channel.

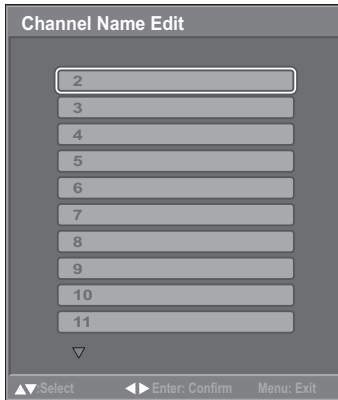

Editing Channel Names

- 1 Use the ◀ / ▶ keys to select **Channel Edit** and press . The Channel Name Edit screen appears.
- 2 Use the ▲ / ▼ keys to select the desired channel and press to open the Edit Name screen.
- 3 Use the ▲ / ▼ / ◀ / ▶ keys to move the cursor to the character you want to enter and press the button to enter characters.
- 4 Select **Accept** when finished.
- 5 Repeat steps 2, 3, and 4 to add more channels.
- 6 Press to save and exit the screen.

SETUP MENUS

MTS

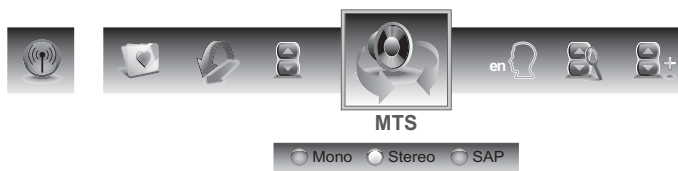

Use MTS to select multichannel television sound.



The following options are available:

- **Mono:** Allows mono output (useful when stereo is noisy or inconsistent).
- **Stereo:** Allows stereo sound for superior TV viewing experience.
- **SAP:** Allows second audio program from the speakers while watching a scene in the original program.

Adjusting MTS



- 1 Use the ◀ / ▶ keys to select **MTS** and press .
- 2 Press the ◀ / ▶ keys on the remote control to select the desired option.
- 3 Press  to save and exit the screen.

Audio Language

Use this sub-menu to select the audio language to **English, French, or Spanish.**



Adjusting Audio Language

- 1 Use the ◀ / ▶ keys to select **Audio Language** and press .
- 2 Press the ◀ / ▶ keys on the remote control to select **English, French** or **Spanish**.
- 3 Press  to save and exit the screen.

Auto Search

Select **Auto Search** and press  and the Auto Search automatically creates a list of receivable channels for the source you select:

- **Cable:** Choose this setting if you are receiving TV channels with a CATV (cable TV)
- **AIR:** Choose this setting if you are receiving TV channels with an antenna (over the air)

Manual Search

Use Manual Search to add channels manually.

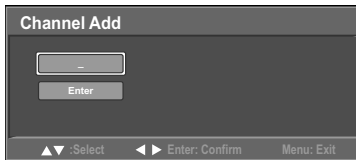

Adding Channels Manually

- 1 Use the ◀ / ▶ keys to select **Manual Search** and press . The Channel Add screen appears.
- 2 Use the Channel keys on the remote control to enter the channel number and select **Enter**. Wait a few moment for the TV to search the channel.
- 3 When the channel is found, you can select **Add** to add to channel.

SETUP MENUS

SETTINGS

Use the Settings sub-menus to configure the LCD TV operational setup and view the current firmware version.

Press  on the remote control or **Menu** on the control panel to display the setup menu screen then select **Settings** to display the Settings sub-menu. The following options are available: Date and Time, Closed Captions, Parental Control, OSD Timeout, OSD Language, Power settings, and Reset All.



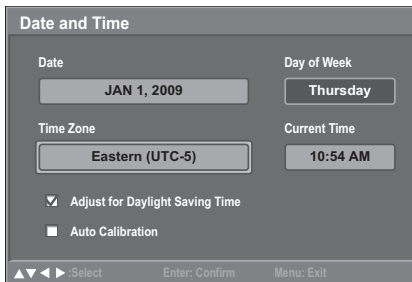

English

Date and Time









Use Date and Time to adjust the current date and time.



Adjusting Auto Calibration

- 1 Use the  /  keys to select **Date and Time** and press .
- 2 Press  repeatedly to check (enable) or uncheck (disable) **Auto Calibration**.
- 3 Press  to save and exit the screen. Enable this option to view the system's current time; Date and Current time options are unavailable for adjustments when Auto Calibration is enabled.

Adjusting Time Zone

- 1 Use the  /  keys to select **Date and Time** and press .
- 2 Use the  /  keys to select **Time Zone** and press .
- 3 Use the  /  keys to select the desired Time Zone: **Samoa, Hawaii, Alaska, Pacific, Mountain, Central, Eastern, Atlantic,** or **Newfoundland**.
- 4 Press  to save and exit the screen.

Adjusting Date and Time

- 1 Use the ◀ / ▶ keys to select **Date and Time** and press **↵**.
- 2 Use the ▲ / ▼ keys to select **Date** or **Current Time** and press **↵**.
- 3 Use the ◀ / ▶ keys to select a date or time segment.
- 4 Use the ▲ / ▼ keys to adjust the value.
- 5 Press **⏏** to save and exit the screen.

Adjusting Daylight Saving

- 1 Use the ◀ / ▶ keys to select **Date and Time** and press **↵**.
- 2 Press **↵** repeatedly to check (enable) or uncheck (disable) **Adjust for Daylight Saving Time**.
- 3 Press **⏏** to save and exit the screen.

Closed Captions

Use Closed Captions to configure the settings for closed captioning in TV programs.

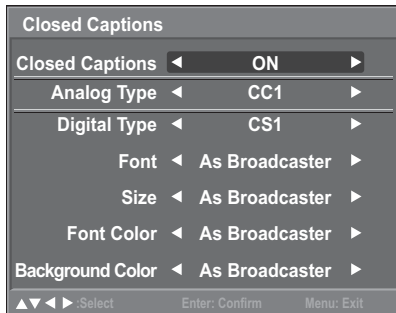



The following options are available:

- **Closed Captions:** Can be set to **ON** (enable) or **OFF** (disable).
- **Analog Type:** Can be set to **CC1, CC2, CC3, CC4, T1, T2, T3, or T4**.
- **Digital Type:** Can be set to **CS1, CS2, CS3, CS4, CS5, or CS6**.

SETUP MENUS

- **Font:** Can be set to **As Broadcaster, Style 1, Style 2, Style 3, Style 4, Style 5, Style 6, or Style 7.**
- **Size:** Can be set to **As Broadcaster, Small, Medium, or Large.**
- **Font Color:** Can be set to **As Broadcaster, Black, White, Green, Blue, Red, Cyan, Yellow, or Magenta.**
- **Background Color:** Can be set to **As Broadcaster, Black, White, Green, Blue, Red, Cyan, Yellow, or Magenta.**

Adjusting Closed Captions Settings

- 1 Use the ◀ / ▶ keys to select **Closed Captions** and press .
- 2 Use the ▲ / ▼ keys to select a desired Closed Captions option.
- 3 Use the ◀ / ▶ keys to adjust the value.
- 4 Press  to save and exit the screen.

Parental Control

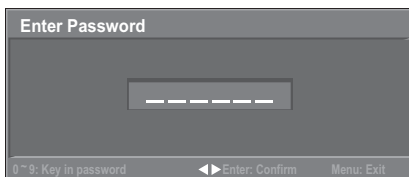

Use Parental Control to block channels and change password. You must enter a six-digit password to use the Parental Control. The factory password is 999999.



The following options are available:

- **Rating:** Select **ON/OFF** to activate/deactivate the Rating programs.
- **Block Unrated:** Select **ON/OFF** to block/unlock all unrated programs.

Adjusting Rating and Block Unrated

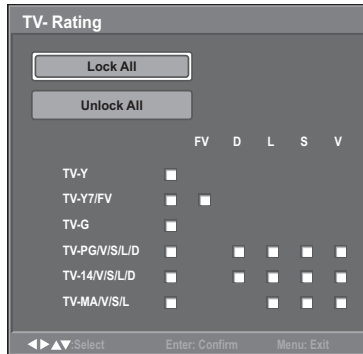

- 1 Use the ◀ / ▶ keys to select **Rating** or **Block Unrated** and press .
- 2 Use the ◀ / ▶ keys to select **ON** (block) or **OFF** (unblock).
- 3 Press  to save and exit the screen.

- **TV Rating:** Use this sub-menu to customize US TV Rating programs.



Rating	Description
TV-Y	Suitable for young children.
TV-Y7	May not be suitable for children under 7.
TV-G	Suitable for all audiences.
TV-PG	Parental guidance suggested.
TV-14	Parental guidance suggested for children under 14.
TV-MA	Suitable for mature audiences only; may be unsuitable for children under 17.
FV	Fantasy violence, combative situations.
D	Suggestive dialogue.
L	L Coarse language.
S	Sexual situations.
V	Violence.

Adjusting TV Rating

- 1 Use the ◀ / ▶ keys to select **TV Rating** and press .
- 2 Use the ▲ / ▼ / ◀ / ▶ keys to select the desired rating and press  repeatedly to block or unblock. You can also select **Lock All** to block all or **Unlock All** to unblock all.
- 3 Press  to save and exit the screen.



SETUP MENUS

- **MPAA Rating:** Use this sub-menu to select the ratings of allowable movies.



Rating	Description
G	Contains nothing most parents will consider offensive for even their youngest children to see or hear; suitable for young children.
PG	May contain some material parents might not like to expose to their young children-material that will clearly need to be examined or inquired about before children are allowed to view the film.
PG-13	May contain some scenes of drug use; use of one of the harsher sexually-derived words may be heard. May be inappropriate for preteens.
R	May contain some adult material. Parents are urged to learn more about the film before letting their children view it.
NC-17	May contain explicit sex scenes, an accumulation of sexually-oriented language, and/or scenes of excessive violence. Suitable for adult audiences only. Rating does not signify that the film is obscene or pornographic.
X	Contains extreme violence or explicit sex; suitable for adult audiences only.

Adjusting MPAA Rating

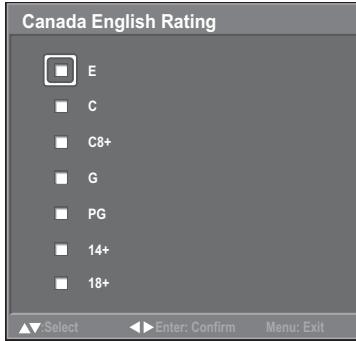

- 1 Use the ◀ / ▶ keys to select **MPAA Rating** and press .
- 2 Use the ▲ / ▼ / ◀ / ▶ keys to select the desired rating and press  repeatedly to block or unblock.
- 3 Press  to save and exit the screen.

- **Canada English:** Use this sub-menu to select the classification categories (based on Canadian ratings) of allowable TV programs and movies.



Rating	Description
C	Suitable for viewing by children of all ages.
C8+	Not suitable for children under 8 years of age.
G	Suitable for general audiences.
PG	Parental guidance advised.
14+	Suitable for people 14 years of age or older.
18+	Suitable for people 18 years of age or older.

Adjusting Canada English Rating

- 1 Use the ◀ / ▶ keys to select **Canada English** and press .
- 2 Use the ▲ / ▼ / ◀ / ▶ keys to select the desired rating and press  repeatedly to block or unblock.
- 3 Press  to save and exit the screen.

SETUP MENUS



English

- **Canada French:** Use this sub-menu to select the ratings of allowable TV programs and movies. These ratings are based on the classification categories determined by La Régie du cinéma du Québec.



Rating	Description
G	For general audiences.
8 ans +	Not suitable for children under 8 years of age.
13 ans+	Not suitable for persons under 13 years of age.
16 ans+	Not suitable for persons under 16 years of age.
18 ans+	Not suitable for persons under 18 years of age.



Adjusting Canada French Rating

- 1 Use the ◀ / ▶ keys to select **Canada French Rating** and press .
- 2 Use the ▲ / ▼ / ◀ / ▶ keys to select the desired rating and press  repeatedly to block or unblock.
- 3 Press  to save and exit the screen.

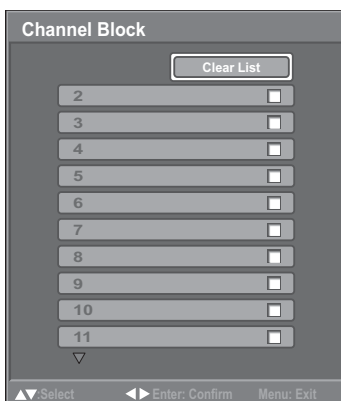



- **V2.0 (Open V-Chip):** V-Chip 2.0 enabled.
- **Channel Block:** Channel Block allows you to block channels.



Adjusting Channel Block

- 1 Use the ◀ / ▶ keys to select **Channel Block** and press .
 - 2 Use the ▲ / ▼ keys to select the desired channel and press  repeatedly to block or unblock.
 - 3 Press  to save and exit the screen.
- **Change Password:** Change password allows you to change your current password.

Changing Password

- 1 Use the ◀ / ▶ keys to select **Change Password** and press .
- 2 Use the Channel keys to enter the current password and press .
- 3 Use the Channel keys to enter the new password and press .
- 4 Use the Channel keys to enter the new password again for confirmation and press .
- 5 Press  to save and exit the screen.



SETUP MENUS

OSD Timeout

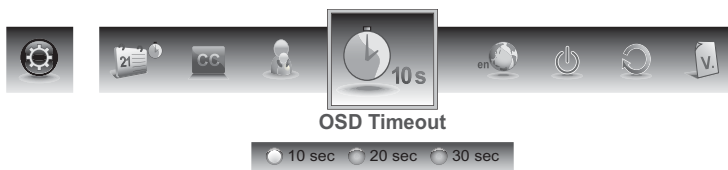
Use OSD Timeout to adjust the OSD duration on the screen: 10 sec, 20 sec, or 30 sec.



Adjusting OSD Timeout



- 1 Use the ◀ / ▶ keys to select **OSD Timeout** and press .
- 2 Press the ◀ / ▶ keys on the remote control to select **10 sec**, **20 sec**, or **30 sec**.
- 3 Press  to save and exit the screen.

OSD Language

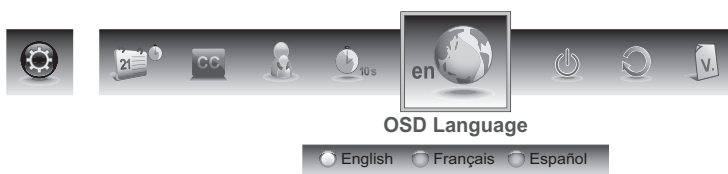
Use OSD Language to select the language to display on the screen: English, French, or Spanish.



Adjusting OSD Language

- 1 Use the ◀ / ▶ keys to select **OSD Language** and press .
- 2 Press the ◀ / ▶ keys on the remote control to select **English**, **French** or **Spanish**.
- 3 Press  to save and exit the screen.

Power Control Settings

Use this sub-menu to configure power-related settings for the LCD TV.

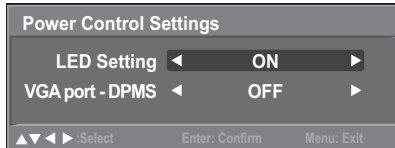



The following options are available:

- **LED Setting:** Use this sub-menu to select the LCD TV power indicator behavior after turning on the set.

LED Behavior	Description
Turns from amber to blue when power on and turn from blue to amber when power off.	When LED Setting is set to ON.
Remains in blue.	When LED Settings is set to OFF.

- **VGA port -DPMS:** Use this setting to enable or disable VGA port -DPMS.

Adjusting Power Control Settings

- 1 Use the ◀ / ▶ keys to select **Power Control Settings** and press .
- 2 Use the ▲ / ▼ keys to select a desired option.
- 3 Use the ◀ / ▶ keys to adjust the value.
- 4 Press  to save and exit the screen.

SETUP MENUS

Reset All

Select **Yes** on this sub-menu to reset all LCD TV operational settings. Do this only if any of the following conditions occurs:

- The system fails to respond to the remote control (make sure the remote control batteries are still working and that you are within the transmission range).
- The new configuration settings caused unexpected results.
- You forget the system PIN.



Version

Use this sub-menu to view the LCD TV's serial number and firmware version.



WALL MOUNT OPTION

The LCD TV has been fitted with VESA FPMPMI compliant mounting holes. These 200 x 100 mm mounting holes allow the unit to be mounted on a wall. Use the four M6 x L10 mm screws to wall mount the LCD TV.

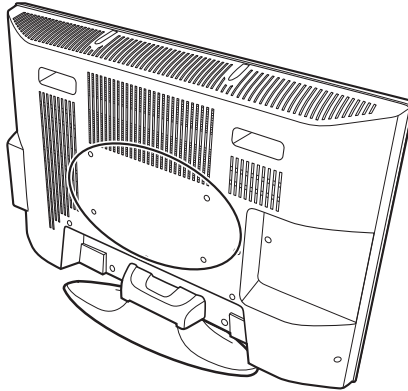

WALL MOUNT INSTALLATION REMINDERS



- Remove the LCD TV base first before mounting the unit on a wall.
- It is the user's responsibility to use a UL listed wall mount unit rated to support the weight of this LCD TV.
- Please consult qualified contractors for wall mount installation.

CAUTION:

The incomplete or improper mounting of this unit to a wall may cause it to fall down resulting to property damage and/or potentially serious injury.

TROUBLESHOOTING

Problem	Corrective Action
No power	<ul style="list-style-type: none">• Make sure the power indicator is illuminated blue.• Make sure the power cord is securely connected to the AC-in jack and is plugged into a functional AC outlet. You may want to plug in another electrical device to the power outlet to verify that it is supplying the proper voltage.
Power is suddenly turned off.	Make sure the sleep timer is turned off.
Forgotten PIN	Use Reset All in Settings menu to reset your password.
Remote control does not work.	<ul style="list-style-type: none">• Press only one button at a time.• Make sure the batteries are properly inserted.• The batteries may already be drained out. Replace batteries with new ones.
Remote control code cannot be detected by a universal remote.	<ul style="list-style-type: none">• Purchase a separate learning remote control.• Go to www.wde.com for a list of remote codes.
No picture	<ul style="list-style-type: none">• Make sure the video input cable is properly connected to the correct terminal, and that the correct input mode is enabled. To illustrate, when a VGA cable is connected to display a computer screen, the PC input mode must be enabled.• Verify that the antenna is properly connected and that the preferred channel is enabled in the channel list. Press and select Channels/Channel List.• Adjust the display settings.

Problem	Corrective Action
No picture or the No Signal message appears when a VGA cable is connected.	<ul style="list-style-type: none"> • Make sure the VGA cable is properly connected to the LCD TV's VGA port. • Decrease the video resolution setting on the computer and try again. • Adjust the display settings.
Picture is cut off or appear in a sidebar screen.	Press  to adjust the Aspect ratio.
Poor image quality in TV mode (cutoff picture, snowy images).	<ul style="list-style-type: none"> • Check your antenna connection. If necessary, rotate the antenna and wait up to ten seconds for a signal. • Reduce signal splitters and excessively long cables. • Replace poor antenna cables and/or connectors to improve signal quality. • Press  to adjust the Aspect ratio. • Adjust the Noise Reduction setting in Picture menu. • In HDMI mode, make sure the external device is compatible with the LCD TV.
Wrong, abnormal or missing colors	<ul style="list-style-type: none"> • If any colors (red, green or blue) are missing, check the video cable to make sure it is securely connected. Loose or broken pins in the cable connector could cause an improper connection. • Adjust the Hue, Saturation and Color Temperature settings in Picture menu. • Connect the TV to another computer and check if the problem is with the computer screen.

TROUBLESHOOTING

English

Problem	Corrective Action
No sound	<ul style="list-style-type: none">• Make sure the audio input cable is properly connected to the correct terminal, and that the correct input mode is enabled.• The volume may be muted, press or Vol+ key to turn on the volume.• Adjust the Bass, Treble, and Balance settings in Audio menu.• If you are using the TV speakers, make sure the TV Speakers option is set to On in Audio menu.• If you are using an external audio device, press and select Audio to make sure the TV Speakers option is set to Off in Audio menu.
<p>NOTES: If the problem condition persists even after performing the recommended corrective actions, contact us by:</p> <ul style="list-style-type: none">• Logging on to www.wde.com• Contacting the Westinghouse Customer Service at (866) 287-5555 or e-mail us at service@wde.com	

SPECIFICATIONS

Item	Specification	
Model Name	SK-26H640G	
Panel	Active Area (Diagonal, mm)	575.769 x 323.712
	Resolution	1366x768
	Brightness (Nits, typ)	450
	Contrast Ratio (Static, typ)	800:1
	Response Time (ms, typ)	5ms
	Aspect Ratio	1.77 (16:9)
	Color Depth	16.7M
	Color Gamut	72%
Audio/Video Input/Output Terminals	<ul style="list-style-type: none"> • HDMI • AV+SV with R/L Audio • YPbPr with R/L Audio • VGA with mini jack blue • SPDIF Out • USB for service • Tuner 	
Speaker Out	5W (2 channels)	
AV Timing	480i/p, 720p, 1080i	
PC Timing	1366x768	
De-interfacing	2D/3D	
Combo Filter	3D	
Power Consumption (Watts)	75W	
Power Consumption (Standby, Watts)	<1W	

SPECIFICATIONS

Item	Specification	
Physical Specifications	Dimensions (WxHxD)	With stand: 657x499x193 mm Without stand: 657x447x99 mm
	Weight (Net)	7.4 kg
	Weight (Gross)	10.1 kg

NOTES:

- These product specifications are subject to change without user notification.
- Do not set your computer graphics card to exceed the unit's refresh rates; doing so may cause damage to the LCD TV.



www.wde.com